

EPR系列 EPR Series

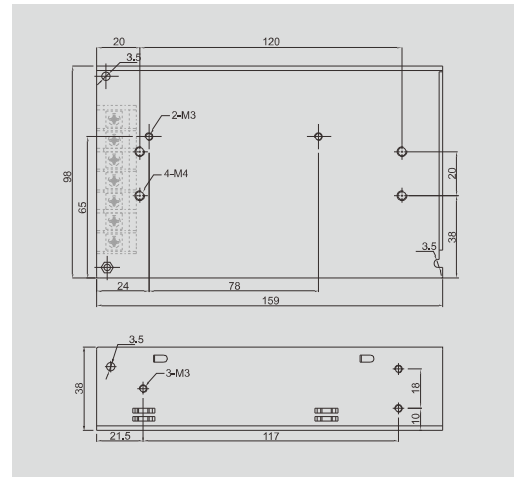

产品特性

- 全范围AC输入
- 通电指示灯
- 过载 / 过压 / 短路保护
- 高可靠性: 105°C长寿命电容, 可耐受300Vac输入电压5秒
- 2年质保

Product features

- Universal AC input / full range
- Power on indication
- Protections: Overload / Over voltage / Short circuit
- High reliability: 105°C capacitor, withstand 300Vac surge input for 5s
- 2 years warranty

技术特性

输入电压	90~264Vac, 127~370Vdc
输入频率	47~63Hz
冲击电流	35A@230Vac 满载冷态
保持时间	≥20ms@230Vac 满载
过载保护	110%~150% 自动恢复
过压保护	110%~145% Vo
运行温度	-20°C~70°C
安全标准	UL60950-1, TUV EN60950-1
EMC标准	EN55032 Class B, EN55024
绝缘标准	I/P-O/P: 1.5kVac, 1min I/P-FG: 1.5kVac, 1min O/P-FG: 0.5kVac, 1min
重量	0.51kg/pcs

Specifications

Input voltage	90~264Vac, 127~370Vdc
Input frequency	47~63Hz
Inrush current	35A@230Vac full load cold start
Hold up time	≥20ms@230Vac full load
Overload protection	110%~150% auto-recovery
Over voltage protection	110%~145% Vo
Operating temperature	-20°C~70°C
Safety standard	UL60950-1, TUV EN60950-1
EMC standard	EN55032 Class B, EN55024
Withstand voltage	I/P-O/P: 1.5kVac, 1min I/P-FG: 1.5kVac, 1min O/P-FG: 0.5kVac, 1min
Weight	0.51kg/pcs

P/N 产品型号	Output 输出	R & N 纹波 & 噪声	Effi. 效率	Load Regulation 负载调整率	DC adjustment range DC可调范围
EPR-100-5	5V, 14A	80mV	76%	± 2%	4.75V~5.25V
EPR-100-12	12V, 8.5A	120mV	81%	± 2%	10.8V~13.2V
EPR-100-15	15V, 6.6A	120mV	81%	± 2%	13.5V~16.5V
EPR-100-24	24V, 4.5A	120mV	84%	± 2%	21.6V~26.4V
EPR-100-36	36V, 2.7A	200mV	84%	± 2%	32.4V~39.6V
EPR-100-48	48V, 2.3A	200mV	84%	± 2%	43.2V~52.8V

另有高可靠型EPR-H系列电源可选, 具备以下特点: 耐受380Vac高压输入2H不坏; 增加三防涂层及端子盖等处理; 低待机功耗。
Another EPR-H series selectable, with high reliability, low stand-by power consumption, conformal coated, connector covered, and withstands 380Vac input running for 2 hours.

平板开关电源 MOUNTED POWER SUPPLY